

VMware View 5.0



TRANSMITTED DATA USING

74% LESS BANDWIDTH



WITHOUT SACRIFICING

QUALITY USER EXPERIENCE

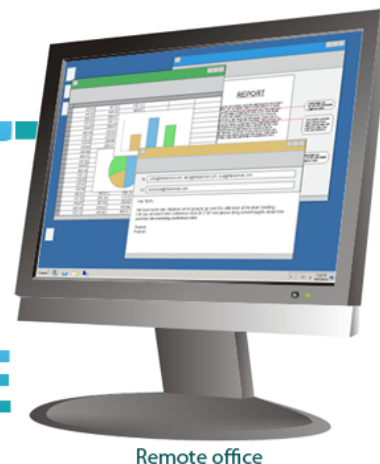

For workers using virtual desktops—in the local office, in remote offices, at home, or elsewhere—the connection to the host server is what drives productivity. Whether they are transferring files, participating in online conferences, or using hosted applications, a desktop virtualization tool that provides a good experience can reduce frustration, optimize productivity, and boost their connectedness to the rest of the organization.

It is essential that your desktop virtualization software deliver a good experience for your workers, even when bandwidth is limited. We tested virtual desktop sessions using VMware View 4.6 and VMware View 5.0 and workloads reflecting those of average workers to see how much bandwidth each application used.

The newer version of View, **VMware View 5.0**, which uses PCoIP Optimization Controls to improve efficiency, **provided the same or better quality user experience as the earlier version, while using up to 74 percent less bandwidth (70 percent less over the WAN)**. This means that workers on virtual desktops under a variety of bandwidth conditions can enjoy an improved user experience over View 4.6.

A GOOD USER EXPERIENCE DESPITE LIMITED BANDWIDTH

Whether virtual desktop infrastructure (VDI) users connect to the host server through a local area network (LAN) or a wide area network (WAN), their ability to do their work well depends on having a virtual desktop that is quick and responsive. Delivering this can be a challenge when bandwidth is limited; users can find themselves subjected to excessive wait times and distractions such as choppy or skipping video, poor response to screen scrolling, inconsistent font size and color, blurring text, and a generally unresponsive system. By using much less bandwidth to transmit data, VMware View 5.0 lets workers enjoy a good experience with typical office workloads, even in a limited-bandwidth situation.

To simulate the experience of such workers, we used three workloads from the Login VSI 3.0 benchmarking tool: light, medium no Flash, and medium (includes Flash). Login VSI 3.0 benchmarks virtual desktop solutions by simulating Windows®-based Microsoft® Office user workloads. For more information on Login VSI 3.0, [see http://www.loginconsultants.com/index.php?option=com_content&task=view&id=496](http://www.loginconsultants.com/index.php?option=com_content&task=view&id=496).

We measured the bandwidth necessary to run the Login VSI workloads in virtual desktops connected two ways: over a LAN with 100Mb/s bandwidth available and over a restricted-bandwidth WAN with 2Mb/s download/300 Kb/s upload and 100m/s latency. We tested both single-session and five-session scenarios. Note: Other test tools are available for comparing VDI performance, including View Planner and RAWC. We opted to use Login VSI because it is not vendor specific and is freely available for medium workloads.

As we show in the Optimizing bandwidth conservation on Windows 7 virtual desktop section in [Appendix B](#), we invoked typical VDI optimizations in our desktop image. We disabled services, disabled boot animation, and removed some visual effects. We did not use PCoIP optimizations like bandwidth modifications or bandwidth ceiling or floor to artificially improve performance.

We conducted the entire gamut of permutations using both VMware View 4.6 and VMware View 5.0, and found that the newer version used as much as 74 percent less bandwidth than the older version.

In addition, we observed the tests in progress to watch for noticeable user experience degradation. The user experience was comparable in all cases, except for the five-session scenario over the WAN with View 4.6, when frames were clearly being dropped during the test runs.

For information for our test system, see [Appendix A](#). For our test methodology, see [Appendix B](#). To see our Login VSI .INI files, see [Appendix C](#).

OUR FINDINGS

In the sections below, we present our findings for the three workloads. One note: In all of the five-session WAN test scenarios, the VMware View 5.0 win percentages were skewed downward because View 4.6 dropped frames due to WAN saturation. This artificially inflated the results for View 4.6 because the benchmark's bandwidth calculations for View 4.6 did not count these dropped frames, which caused a degraded user experience noticeable during testing. VMware View 5.0 delivered a **better** user experience in all five-session WAN test scenarios.

Light workload



The Login VSI light workload runs fewer applications than the medium workloads with and without Flash, and closes applications soon after using them, as a typical task worker would do. In this workload, two applications are open simultaneously. The applications include the following:

- Microsoft Internet Explorer® browser
- Microsoft Word
- Microsoft Outlook®

Single-session scenario

As Figure 1 shows, when running a light workload over a LAN, VMware View 5.0 reduced bandwidth over View 4.6 by 74 percent for a single virtual desktop session and delivered a similar or better user experience.

Figure 1: LAN light workload bandwidth usage results for a single session. Lower numbers are better.

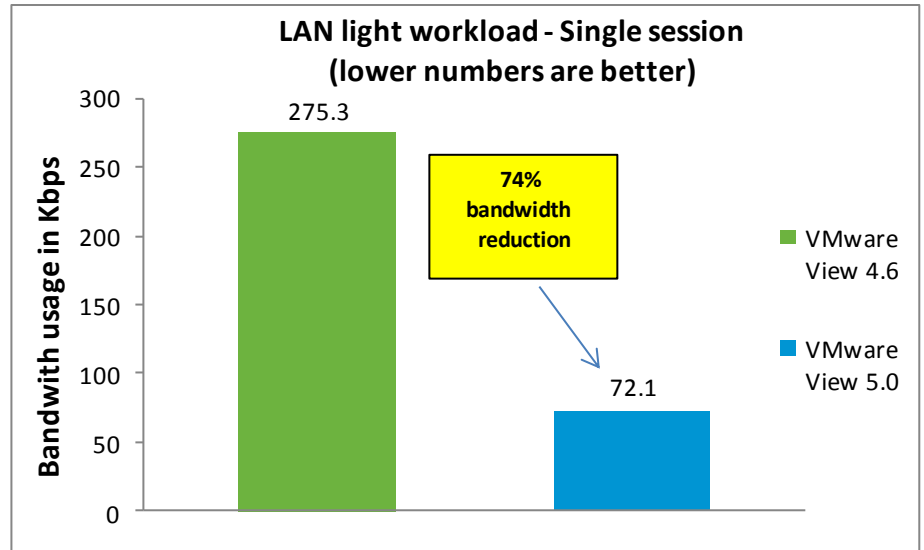

As Figure 2 shows, when running the light workload over a WAN, VMware View 5.0 reduced bandwidth over View 4.6 by 70 percent for a single virtual desktop session and delivered a similar or better user experience.

Figure 2: WAN light workload bandwidth usage results for a single session. Lower numbers are better.

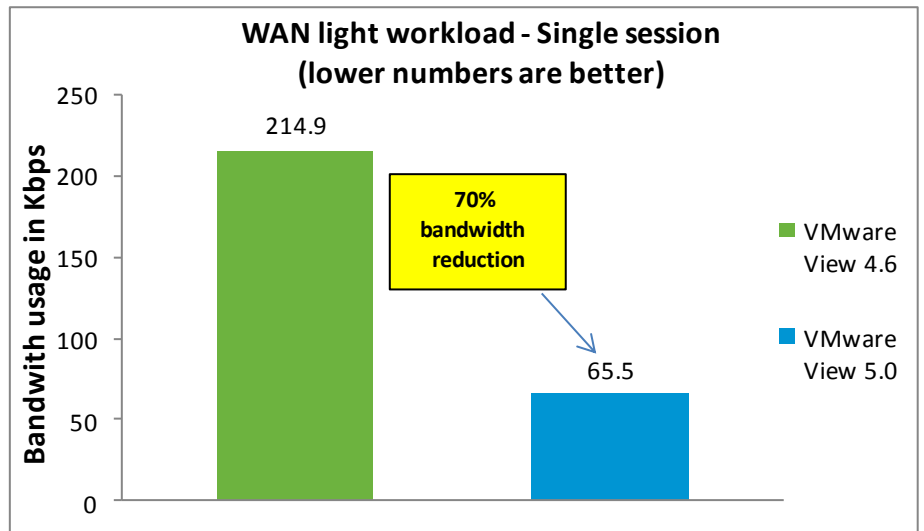

Five-session scenario

As Figure 3 shows, when running the light workload on five sessions over a LAN, VMware View 5.0 again reduced bandwidth over View 4.6 by 74 percent and delivered a similar or better user experience.

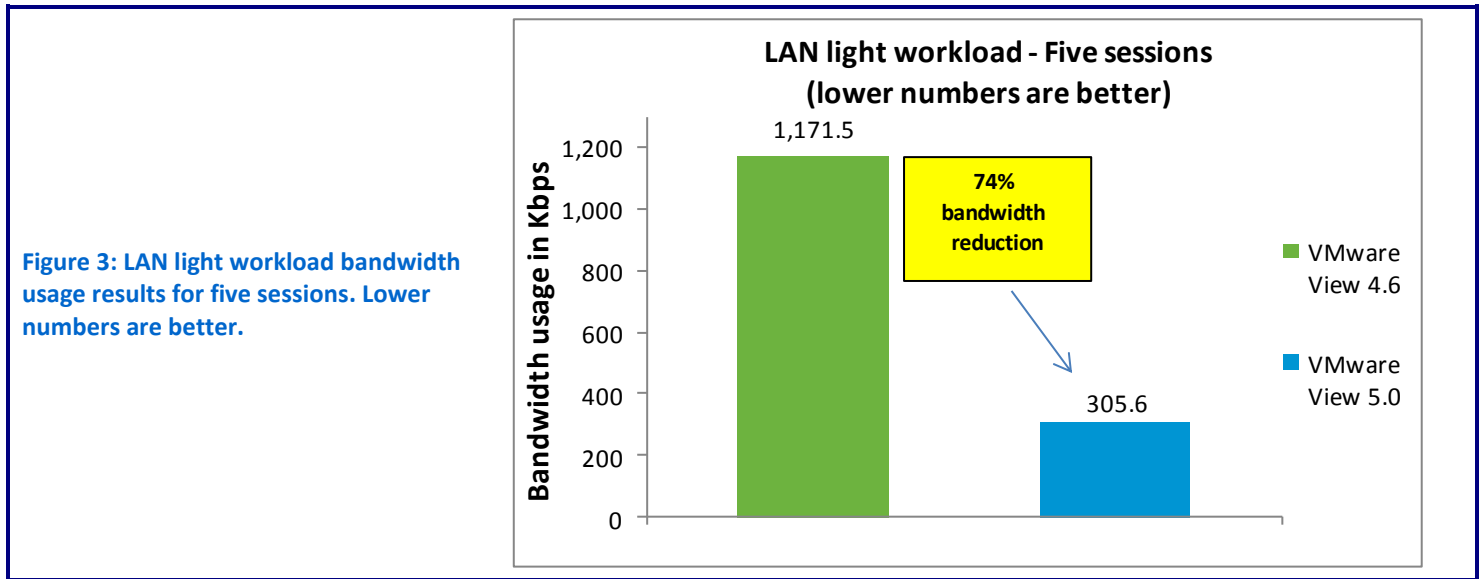

As Figure 4 shows, when running the light workload on five sessions over a WAN, VMware View 5.0 reduced bandwidth over View 4.6 by 68 percent and delivered a **better** user experience.

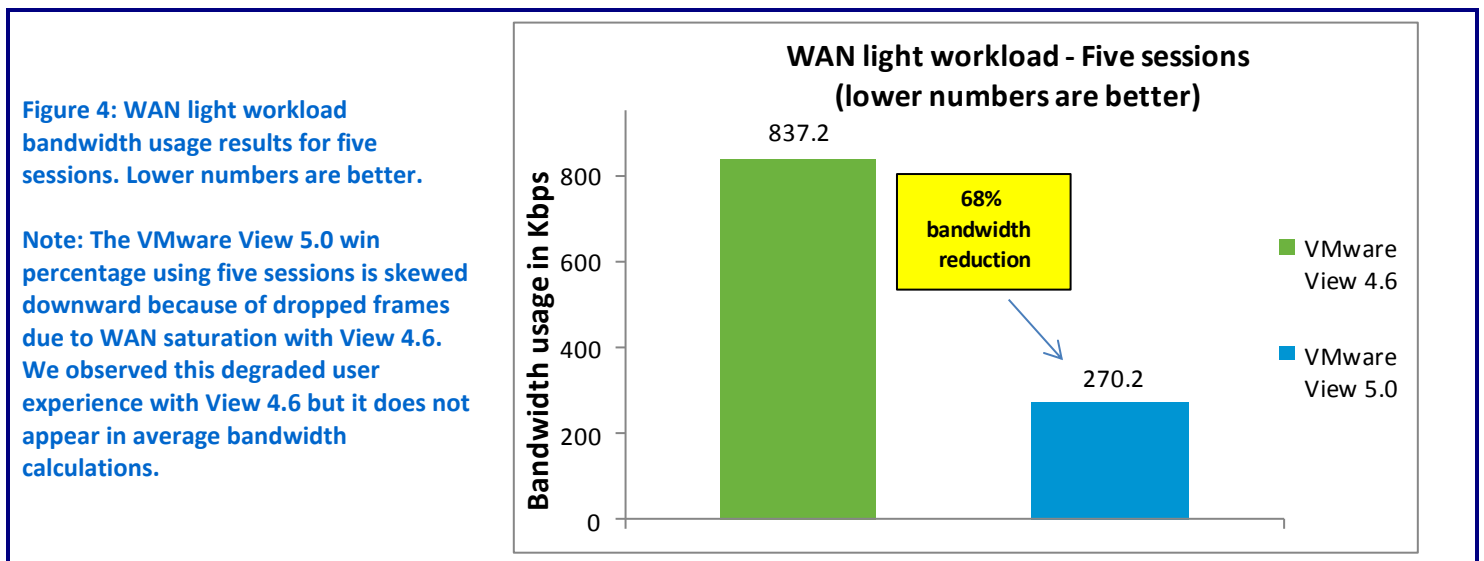

Median bandwidth results

Figure 5 shows the median bandwidth, in Kbps, for VMware View 4.6 and VMware View 5.0 running the light workload on both the single- and five-session scenarios over both LAN and WAN connections. VMware View 5.0 consistently delivered a similar or better user experience.

In addition to using more bandwidth than View 5.0, View 4.6 also provided noticeably degraded user experience in the five-session WAN scenario. View 4.6 gradually loads the desktop when the bandwidth available is insufficient to fully render text and images. This behavior, referred to as “Build to lossless,” is visually distracting. We observed screen blurring, screen choppiness, font discontinuity, and incomplete screen rendering.

Light workload			
Activity	VMware View 4.6	VMware View 5.0	Percentage VMware View 5.0 win
Single-session scenario			
LAN	275.35	72.07	74%
WAN	214.90	65.50	70%
Five-session scenario			
LAN	1,171.53	305.58	74%
WAN	837.20	270.19	68%

Figure 5: Median WAN and LAN testing results, in Kbps, for the light workload. Lower numbers are better (except for percentage win).

Medium workload no Flash



The Login VSI medium no Flash workload simulates a medium-level knowledge worker using Microsoft Office, Internet Explorer, and PDFs. This workload completes the following tasks in different applications:

- Microsoft Outlook: Browsing a message
- Microsoft Word (TimerDoc): Initiate response timer to see how the program responds throughout the workload
- Microsoft Internet Explorer instance one: Maximizing, scrolling, and minimizing
- Microsoft Internet Explorer instance two: Navigating a Web site, maximizing, and scrolling
- Microsoft Word (UserRead): Reading and typing text, and printing to PDF
- Bullzip: Generating a PDF
- Adobe Reader®: Reading a PDF
- Microsoft PowerPoint®: Watching a presentation and adding a slide
- Microsoft Excel®: Reading and minimizing
- 7-Zip: Saving a zip file

Single-session scenario

As Figure 6 shows, when running the medium workload without Flash over a LAN, VMware View 5.0 reduced bandwidth over View 4.6 by 59 percent for a single virtual desktop session, and delivered a similar or better user experience.

Figure 6: LAN medium workload without Flash bandwidth usage results for a single session. Lower numbers are better.

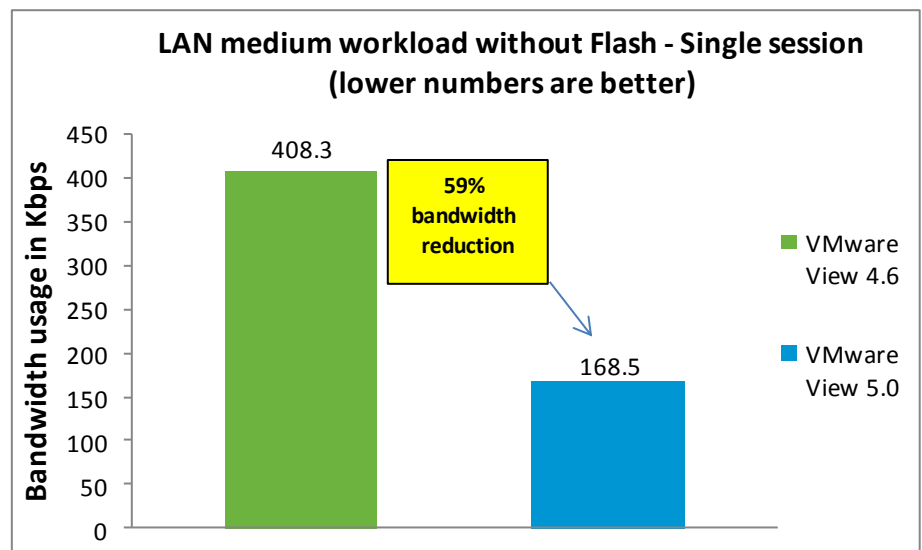

As Figure 7 shows, when running the medium workload without Flash over a WAN, VMware View 5.0 reduced bandwidth over View 4.6 by 54 percent for a single virtual desktop session, and delivered a similar or better user experience.

Figure 7: WAN medium workload without Flash bandwidth usage results for a single session. Lower numbers are better.

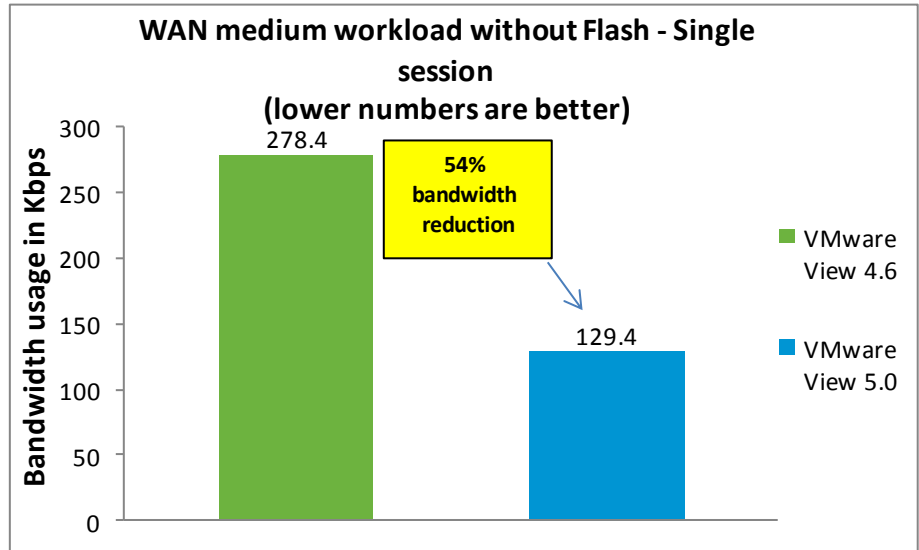

Five-session scenario

As Figure 8 shows, when running the medium workload without Flash on five sessions over a LAN, VMware View 5.0 reduced bandwidth over View 4.6 by 57 percent, and delivered a similar or better user experience.

Figure 8: LAN medium workload without Flash bandwidth usage results for five sessions. Lower numbers are better.

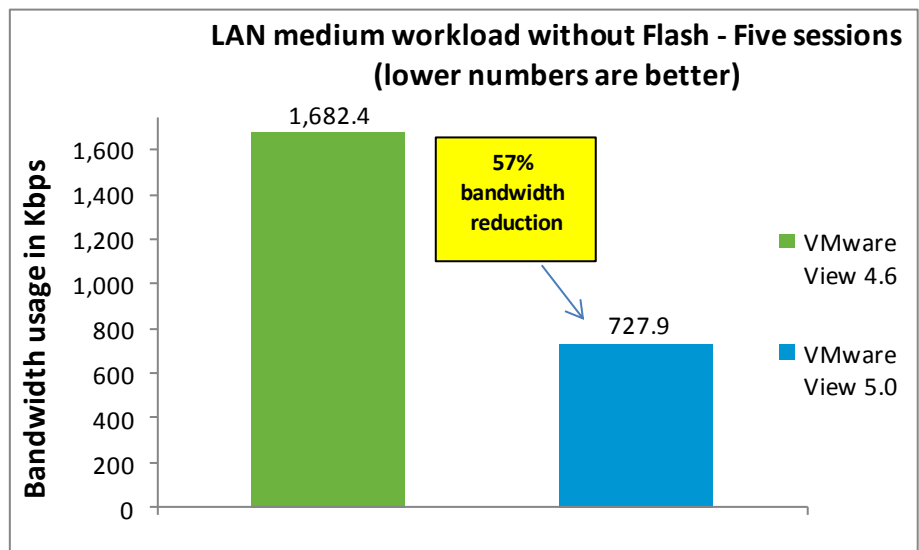

As Figure 9 shows, when running the medium workload without Flash on five sessions over a WAN, VMware View 5.0 reduced bandwidth over View 4.6 by 48 percent and delivered a **better** user experience.

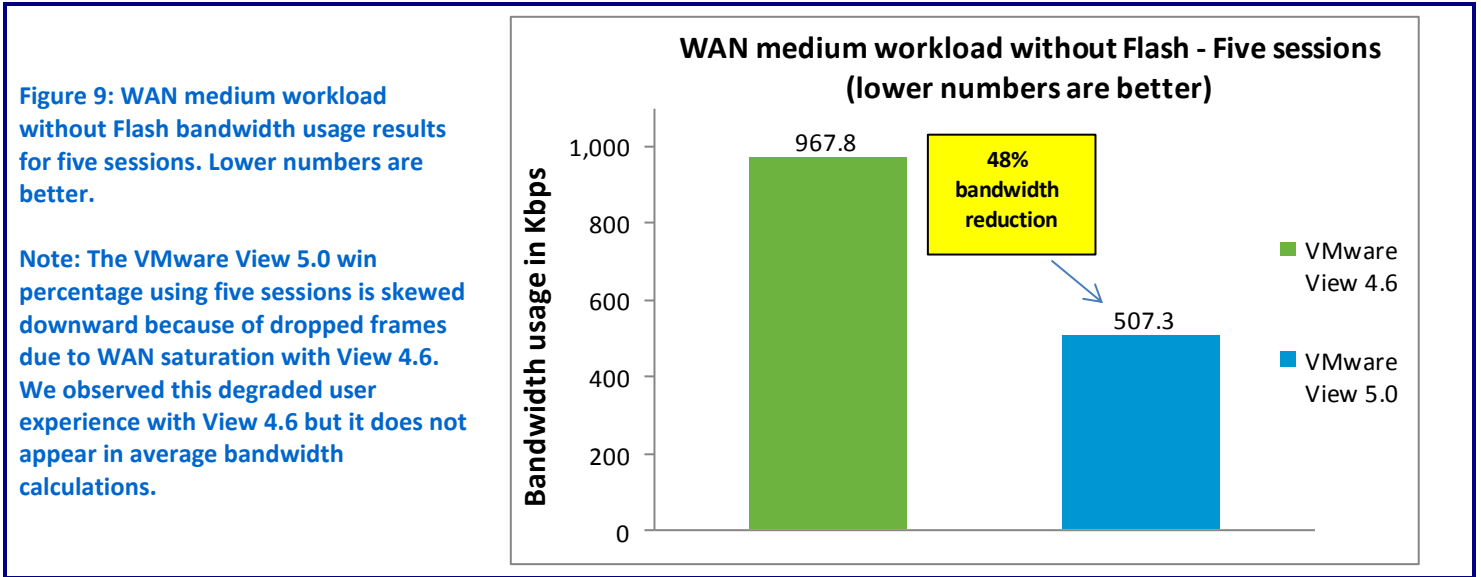

Median bandwidth results

Figure 10 shows the median bandwidth, in Kbps, for VMware View 4.6 and VMware View 5.0 running the medium workload without Flash in both single- and five-session test scenarios over both LAN and WAN connections. VMware View 5.0 consistently delivered a similar or better user experience.

As with the light workload, VMware View 4.6 not only used more bandwidth than View 5.0, but also noticeably degraded the user experience in the five-session WAN test scenario because of the Build to lossless behavior we describe earlier.

Medium workload without Flash			
Activity	VMware View 4.6	VMware View 5.0	Percentage VMware View 5.0 win
Single-session scenario			
LAN	408.25	168.55	59%
WAN	278.43	129.36	54%
Five-session scenario			
LAN	1,682.41	727.86	57%
WAN	967.77	507.26	48%

Figure 10: Median WAN and LAN testing results, in Kbps, for the medium workload without Flash. Lower numbers are better (except for percentage win).

Medium workload with Flash



The Login VSI medium workload (with Flash) simulates a medium-level knowledge worker using Microsoft Office, Internet Explorer, and PDFs. This workload completes the following tasks in different applications:

- Microsoft Outlook: Browsing a message
- Microsoft Word (TimerDoc): Initiate response timer to see how the program responds throughout the workload
- Microsoft Internet Explorer instance one: Maximizing, scrolling, and minimizing
- Microsoft Internet Explorer instance two: Navigating a Web site, maximizing, and scrolling
- Adobe Flash®: Viewing a movie trailer
- Microsoft Word (UserRead): Reading and typing text, and printing to PDF
- Bullzip: Generating a PDF
- Adobe Reader: Reading a PDF
- Microsoft PowerPoint®: Watching a presentation and adding a slide
- Microsoft Excel: Reading and minimizing
- 7-Zip: Saving a zip file

Single-session scenario

As Figure 11 shows, when running the medium workload with Flash over a LAN, VMware View 5.0 reduced bandwidth over View 4.6 by 34 percent for a single virtual desktop session, and delivered a similar or better user experience.

Figure 11: LAN medium with Flash workload bandwidth usage results for a single session. Lower numbers are better.

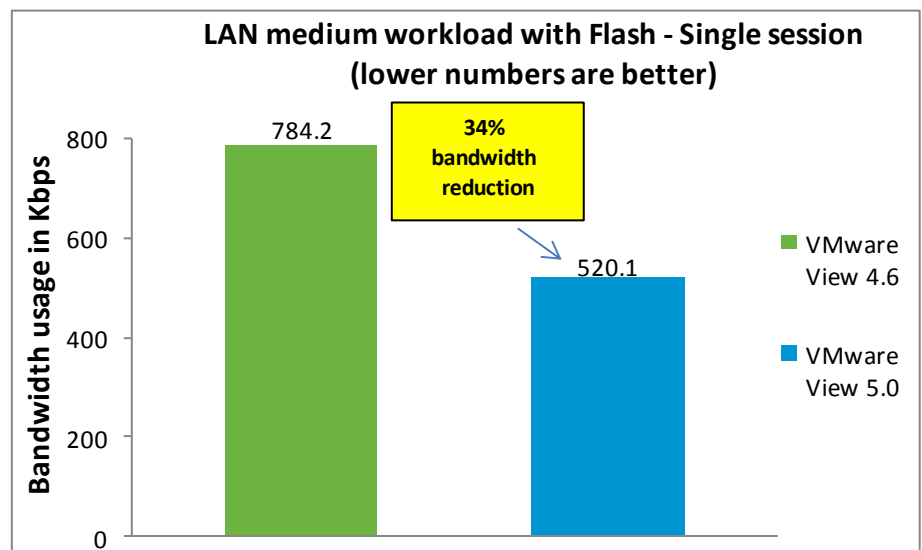

As Figure 12 shows, when running the medium workload with Flash over a WAN, VMware View 5.0 reduced bandwidth over View 4.6 by 46 percent for a single virtual desktop session and delivered a similar or better user experience.

Figure 12: WAN medium with Flash workload bandwidth usage results for a single session. Lower numbers are better.

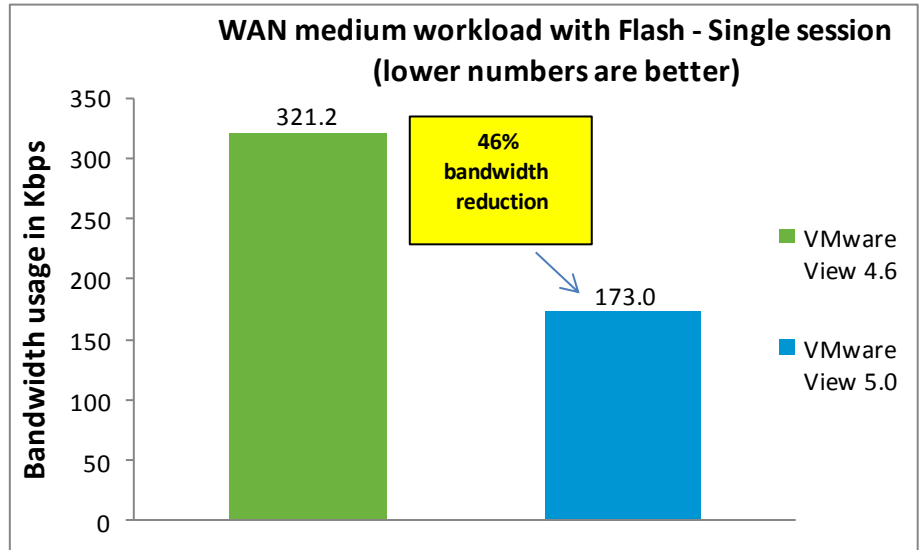

Five-session scenario

As Figure 13 shows, when running the medium workload with Flash on five sessions over a LAN, VMware View 5.0 reduced bandwidth over View 4.6 by 34 percent, and delivered a similar or better user experience.

Figure 13: LAN medium workload with Flash bandwidth usage results for five sessions. Lower numbers are better.

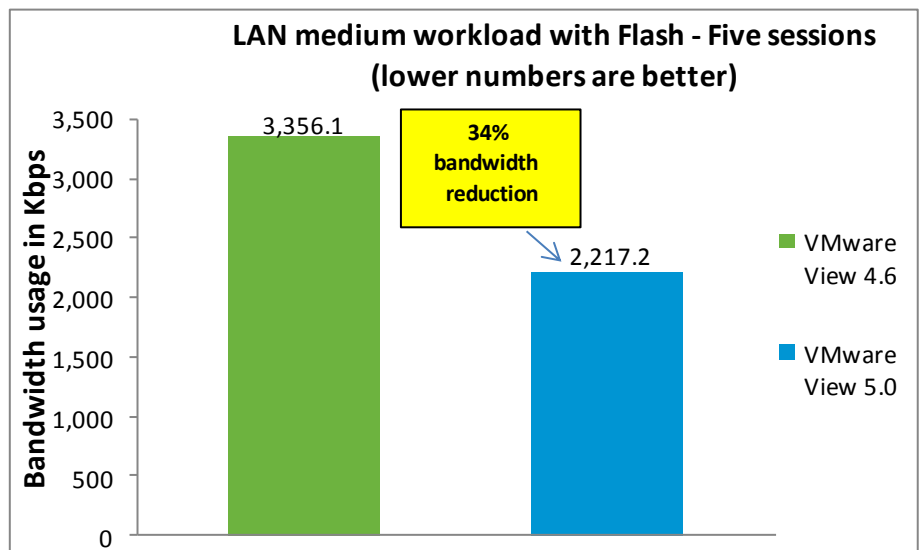

As Figure 14 shows, when running the medium workload with Flash on five sessions over a WAN, VMware View 5.0 reduced bandwidth over View 4.6 by 43 percent, and delivered a **better** user experience.

Figure 14: WAN medium workload with Flash bandwidth usage results for five sessions. Lower numbers are better.

Note: The VMware View 5.0 win percentage using five sessions is skewed downward because of dropped frames due to WAN saturation with View 4.6. We observed this degraded user experience with View 4.6, but it does not appear in average bandwidth calculations.

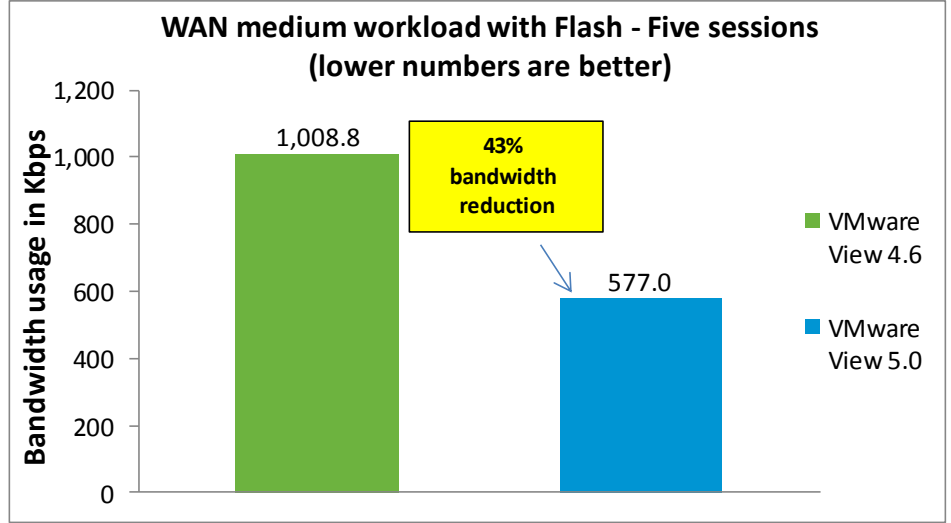

Median bandwidth results

Figure 15 shows the median bandwidth, in Kbps, for VMware View 4.6 and VMware View 5.0 running the medium workload with Flash in both single- and five-session test scenarios over both LAN and WAN connections. VMware View 5.0 consistently delivered a similar or better user experience.

As with the light workload and medium workload without Flash, VMware View 4.6 not only used more bandwidth than View 5.0, but also noticeably degraded the user experience in the five-session WAN test scenario because of the Build-to-lossless behavior we describe earlier.

Medium workload with Flash			
Activity	VMware View 4.6	VMware View 5.0	Percentage VMware View 5.0 win
Single-session scenario			
LAN	784.19	520.14	34%
WAN	321.23	172.96	46%
Five-session scenario			
LAN	3,356.06	2,217.20	34%
WAN	1,008.81	577.03	43%

Figure 15: Median WAN and LAN testing results, in Kbps, for the medium workload with Flash. Lower numbers are better (except for percentage win).

FINAL THOUGHTS

For your virtual desktop infrastructure, where workers connect from the local office or across a larger geographic area, you need the best possible performance so that employees can have a good user experience and do their work without delay.

In our tests, VMware View 5.0 showed marked improvements over previous View 4.6 version. View 5.0 decreased bandwidth over View 4.6 by as much as 74 percent on LAN tests and 70 percent on WAN tests while delivering equal or better user experience, showing that VMware View 5.0 can provide you and your workers with the session quality they need, especially in situations where bandwidth comes at a premium.

WHAT WE TESTED

What's new in VMware View 5.0

VMware View is desktop virtualization software designed to bring users familiarity, flexibility, and great performance, while providing the IT department with simplified management and increased security. Some of the new features in VMware View 5.0 from View 4.6 include the following:

View Media Services for 3D Graphics. Allows View desktops to view basic 3D applications (Microsoft® Office 2010, Microsoft Windows® Aero®), as well as DirectX® and OpenGL® applications, without requiring client devices or specialized graphic cards.

View Media Services for Integrated Unified Communications. Optimizes desktop and unified communications by providing users with an integrated voice-over IP (VOIP) and View desktop experience.

View Persona Management. Enables IT admins to deploy and manage stateless floating desktops by dynamically associating a user persona to such desktops. This also allows user personalization settings to remain between sessions. Note that this feature is only available in premier editions of View.

PCoIP Extension Services. To improve user support issues such as monitoring, trending, and troubleshooting, these features allow WMI-based tools to collect over 20 session statistics.

PCoIP Optimization Controls. Helps IT administrators better configure bandwidth settings (by user, use case, or network requirements), which can reduce bandwidth by up to 75 percent and improve protocol efficiency.

PCoIP Continuity Services. Automatically reconnects interrupted sessions, which helps provide a seamless user experience even under unreliable network conditions.

View Client for Android. Allows those users with Android-based tablets to access View virtual desktops.

Enhanced Security Settings. Customizes client certificate handling through use of an established browser certificate model, which reinforces corporate policy.

vSphere 5 support. Provides reliable and flexible IT support.

USB Redirect. Provides ability to connect USB devices to the virtualized desktop

Location-based printing from non-Windows devices. Allows VMware View administrators to specify the printers that Windows and non-Windows users print to based on the location of the device from which they are accessing VMware View.

Client security certificate handling. Added more policies for security including: Prompt user to accept and ignore certificate warnings, Disable security certificate checking, and Mandatory certification checking.

About Dell EqualLogic storage

We used the Dell™ EqualLogic™ PS4000XV to host all the virtual desktops in our testing.

The Dell EqualLogic PS4000XV is a high-performance iSCSI SAN storage array well suited for deploying business application and virtual server environments in remote offices and in small-to-medium businesses (SMBs). With its use of automation, the EqualLogic PS4000XV simplifies management and is ready for quick deployment at an affordable price.

The EqualLogic comes with 15,000 RPM SAS disk drives to offer strong random I/O per second (IOPS) for deployment in remote offices, and scales easily should you need to expand your storage. For more information on the Dell EqualLogic PS4000XV, visit <http://www.dell.com/us/business/p/equallogic-ps4000xv/pd>.

APPENDIX A: TEST SERVER AND STORAGE CONFIGURATION

Figure 16 provides detailed configuration information for the test servers, and Figure 17 provides configuration information for the Dell EqualLogic PS4000XV storage array.

System	Dell PowerEdge R810 server	Dell PowerEdge R910 server
Power supplies		
Total number	2	4
Vendor and model number	Dell	Dell
Wattage of each (W)	1,100	1,100
Cooling fans		
Total number	6	6
Vendor and model number	Sanyo Denki 9GA0612P1K611	Delta Electronics Inc. PFC1212DE
Dimensions (h x w) of each	80mm x 80mm	120mm x 38mm
Volts	12	12
Amps	0.95	4.80
General		
Number of processor packages	2	2
Number of cores per processor	8	8
Number of hardware threads per core	16	16
System power management policy	Active Power Controller	Active Power Controller
CPU		
Vendor	Intel®	Intel
Name	Xeon®	Xeon
Model number	X7560	X7560
Stepping	D0	D0
Socket type	LGA 1565	LGA 1565
Core frequency (GHz)	2.26	2.26
Bus frequency (MHz)	3,200	3,200
L1 cache	8 x 32KB Data 8 x 32KB Instruction	8 x 32KB Data 8 x 32KB Instruction
L2 cache	8 x 256 KB	8 x 256 KB
L3 cache (MB)	24	24
Platform		
Vendor and model number	PowerEdge™ R810	PowerEdge R910
Motherboard model number	FD32M	P658H
BIOS name and version	Dell Inc. 2.2.3	Dell Inc. 2.2.3

System	Dell PowerEdge R810 server	Dell PowerEdge R910 server
BIOS settings	Default	Default
Memory module(s)		
Total RAM in system (GB)	256	256
Vendor and model number	SamsungM393B1k708H1-CH9	Samsung M393B1G70DJ1-CF8
Type	PC3-10600	PC3-8500R
Speed (MHz)	1,333	1,066
Speed running in the system (MHz)	1,067	1,067
Timing/Latency (tCL-tRCD-tRP-tRASmin)	7-7-7-34.7	7-7-7-34.7
Size (GB)	8	8
Number of RAM module(s)	32	32
Chip organization	Dual	Dual
Rank	2Rx4	4Rx4
Operating system		
OS #1		
Name	ESXi 4.1.0	ESXi 5.0.0
File system	VMFS	VMFS
Kernel	4.1.0	5.0.0
Language	English	English
OS #2		
Name	ESXi 5.0.0	N/A
File system	VMFS	N/A
Kernel	5.0.0	N/A
Language	English	N/A
RAID controller		
Vendor and model number	PERC H700	PERC H700
Firmware version	12.10.1-0001	12.10.1-0001
Cache size (MB)	512	512
Hard drives		
Vendor and model number	Dell/Seagate ST973452SS	Dell/Seagate ST9146852SS
Number of drives	2	16
Size (GB)	73	146
RPM	15,000	15,000
Type	SAS	SAS
Onboard Ethernet adapters		
Vendor and model number	Broadcom® NetXtreme® II BCM5709	Broadcom NetXtreme II BCM5709
Type	Integrated	Integrated

System	Dell PowerEdge R810 server	Dell PowerEdge R910 server
Optical drive(s)		
Vendor and model number	TEAC DV-28S	TEAC DV-28S
Type	SATA	SATA
USB ports		
Number	4	4
Type	2.0	2.0

Figure 16: Detailed configuration information for the test servers.

Storage array	Dell EqualLogic PS4000XV storage array
Array	1
Number of active storage controllers	1
Number of active storage ports	2
Firmware revision	5.0.7
Switch number/type/model	PowerConnect™ 5448
Disk vendor and model number	Seagate ST330065SS
Disk size (GB)	300
Disk buffer size (MB)	16
Disk RPM	15,000
Disk type	SAS

Figure 17: Detailed configuration information for the storage array.

APPENDIX B: TEST METHODOLOGY

Here, we explain the detailed steps we followed to set up our test scenario. Figure 18 shows our test environment.

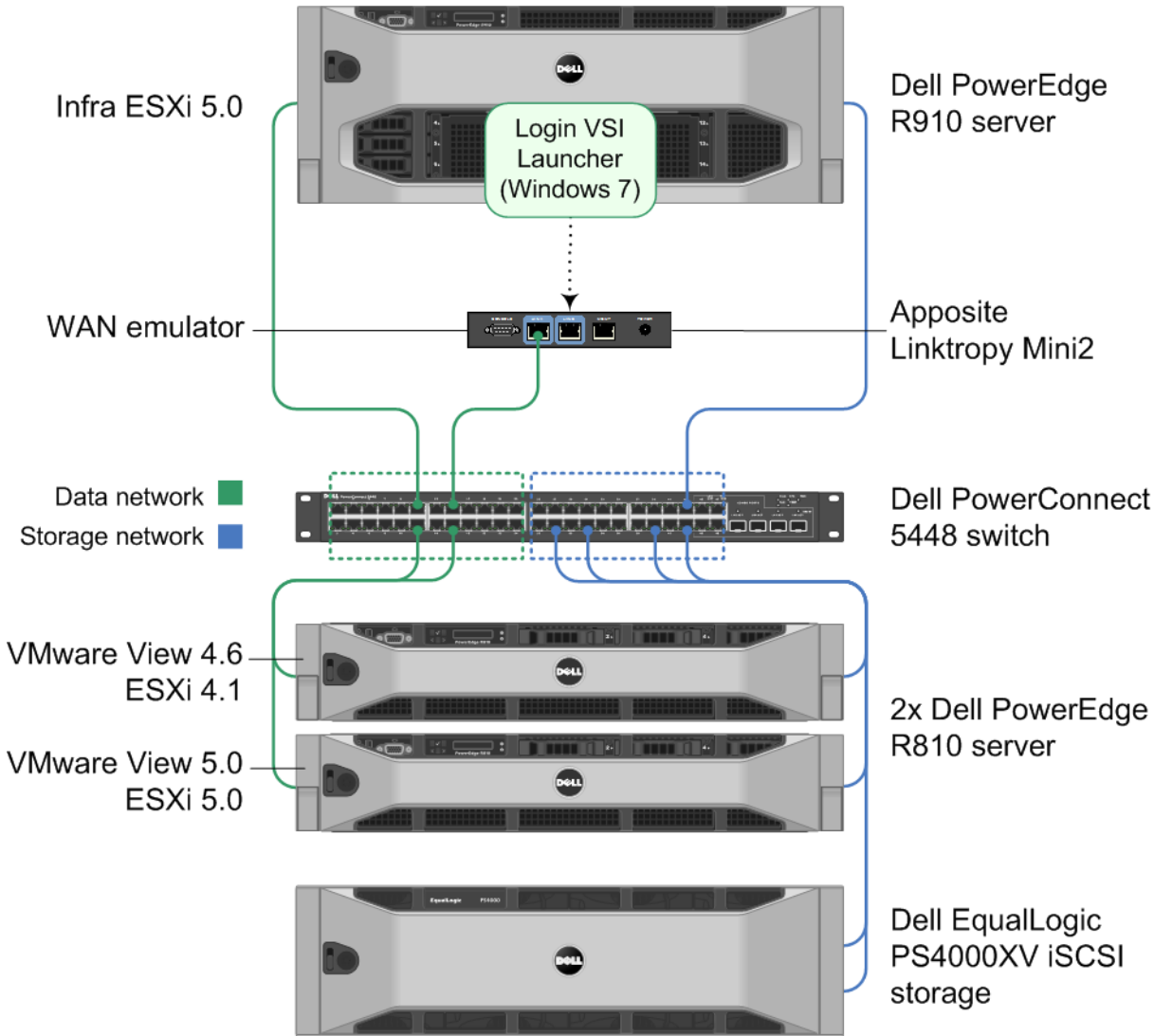

Figure 18: Our test environment.

We configured a Dell PowerEdge R910 with VMware vSphere (ESXi) 5.0 to host all VDI infrastructure components for VMware View 4.6 and VMware View 5.0. We installed a Dell PowerEdge R810 with VMware vSphere 5.0 to host all VMware View 5.0 virtual desktops. We installed a second identical Dell PowerEdge R810 with VMware vSphere 4.1 to host all VMware View 4.6 virtual desktops.

We installed and configured a Dell PowerConnect™ 5448 switch with two logical networks, one network for data traffic and another for iSCSI storage traffic. We connected each Dell PowerEdge R810 server to both the data network and to the storage network. We then installed and configured an Apposite® Linktropy Mini2 WAN emulator and connected the A side of the Apposite Linktropy Mini2 to the data network, and the B side directly to the Dell PowerEdge

R910 (for the Login VSI launcher connection). Note: We configured the Linktropy Mini2 to emulate a over a restricted-bandwidth WAN with 2 Mb/s download/300 Kb/s upload and 100 m/s latency.

We connected a Dell EqualLogic PS4000XV storage array to the storage network via two single gigabit links, and configured the array to host the virtual desktops.

Setting up the storage

Dell EqualLogic PS5000XV storage

We installed the Dell PowerEdge R910 server to use internal storage to host the ESXi operating system. We configured the Dell PERC H700 array controller to use 16 146GB SAS disks in a RAID 10 configuration to host the ESXi hypervisor and infrastructure virtual machines.

We installed both Dell PowerEdge R810 servers to use internal storage to host the ESXi operating systems. We configured the integrated PERC 7i array for a RAID 1 configuration with two 73GB SAS drives. We hosted all virtual desktops on a Dell EqualLogic PS4000XV Storage array.

We enabled jumbo frames on all iSCSI-dedicated server NICs, the Dell PowerConnect 5448 switch, and on each NIC on the Dell EqualLogic PS4000XV storage.

The Dell EqualLogic PS4000XV contained 16 drives. We configured a single storage group with the Dell EqualLogic PS4000XV as the only member. We configured the storage group to have a single storage pool in RAID 50 mode. On the storage pool, we created two 250GB LUNs: one for VMware View 4.6 virtual desktops, and one for VMware View 5.0 virtual desktops.

Setting up the internal storage on the Dell PowerEdge R910 for host operating system installation

1. Enter the RAID controller BIOS by pressing Ctrl+R at the relevant prompt during boot.
2. Highlight Controller 0, and press F2.
3. Select Create New VD.
4. Select all 16 drives, select RAID level 10, tab to the OK button, and press Enter. Accept the warning regarding initialization.
5. Select the new virtual drive, press F2, and select Initialization, Start Init.
6. Wait for the initialization operation to complete.
7. Repeat steps 2 through 6 for the remaining internal volume, selecting drives three and four.
8. Press Escape, and choose to Save and Exit to return to the boot sequence.

Setting up the internal storage on the two Dell PowerEdge R810s for host operating system installation

1. Enter the RAID controller BIOS by pressing Ctrl+R at the relevant prompt during boot.
2. Highlight Controller 0, and press F2.
3. Select Create New VD.
4. Select both drives, select RAID level 1, tab to the OK button, and press Enter. Accept the warning regarding initialization.
5. Select the new virtual drive, press F2, and select Initialization, Start Init.
6. Wait for the initialization operation to complete.
7. Press Escape, and choose to Save and Exit to return to the boot sequence.
8. Repeat steps 1 through 7 for the second Dell PowerEdge R810.

Setting up the external storage

1. Using the command-line console, via serial cable, reset the first Dell EqualLogic PS4000XV by using the reset command.

2. Supply a group name, group IP address, and IP address for eth0.
3. After group creation, using a computer connected to the same subnet as the storage, use the Dell EqualLogic Web interface to do the following:
 - a. Assign IP addresses on the remaining NIC (eth1). Enable both NICs.
 - b. Set a MTU size of 9,000 on each NIC on the array.
 - c. Create a storage pool by right-clicking Storage pools, and choosing Create storage pool.
 - d. Choose Yes when prompted to configure the member.
 - e. Choose RAID 50 for the RAID Policy.
 - f. Create a 250GB volume to host the data volumes for VMware View 5.0.
 - g. For the volumes created in the previous step, limit access to iSCSI initiator name, and enter the initiator name for the ESXi server named view5.
 - h. Repeat steps e through g to create a second 250GB LUN for VMware View 4.6. Be sure to adjust the iSCSI initiator name for the ESXi server named view46.

Setting up the infrastructure server (infra) and the virtual desktop hosts (view46 and view5)

BIOS settings

We used the latest BIOS updates on each of the two Dell PowerEdge R810s and the Dell PowerEdge R910. We adjusted the default BIOS settings by enabling Virtualization Technology, disabling C-States, and setting the performance profile to maximum performance.

Installing VMware vSphere 5.0 (ESXi) on the PowerEdge R910 (infra)

1. Insert the ESXi 5.0 disk, and select Boot from disk.
2. On the Welcome screen, press Enter.
3. On the End User License Agreement (EULA) screen, press F11.
4. On the Select a Disk to Install or Upgrade Screen, select the relevant volume to install ESXi on, and press Enter.
5. On the Please Select a Keyboard Layout screen, press Enter.
6. On the Enter a Root Password Screen, assign a root password, and confirm it by entering it again. Press Enter to continue.
7. On the Confirm Install Screen, press F11 to install.
8. On the Installation complete screen, press Enter to reboot.

Configuring ESXi after installation

1. On the ESXi 5.0 screen, press F2, enter the root password, and press Enter.
2. On the System Customization screen, select Troubleshooting Options, and press Enter.
3. On the Troubleshooting Mode Options screen, select enable ESXi Shell, and press Enter.
4. Select Enable SSH, press Enter, and press Esc.
5. On the System Customization screen, select Configure Management Network.
6. On the Configure Management Network screen, select IP Configuration.
7. On the IP Configuration screen, select Set static IP; enter an IP address, subnet mask, and default gateway; and press Enter.
8. On the Configure Management Network screen, press Esc. When asked if you want to apply the changes, press Y.
9. Log into infra as `root` with the vSphere client.
10. Select the Configuration tab, and click Networking.
11. Click Add Networking...
12. Create a virtual machine network called `data` and select the appropriate adapter.
13. Create a virtual machine network called WAN and select the adapter connected directly to the Apisite Linktropy Mini2.

14. Log off.

Installing VMware vSphere 5.0 (ESXi) on the PowerEdge R810 (view5)

1. Insert the ESXi 5.0 disk, and select Boot from disk.
2. On the Welcome screen, press Enter.
3. On the End User License Agreement (EULA) screen, press F11.
4. On the Select a Disk to Install or Upgrade Screen, select the relevant volume to install ESXi on, and press Enter.
5. On the Please Select a Keyboard Layout screen, press Enter.
6. On the Enter a Root Password Screen, assign a root password, and confirm it by entering it again. Press Enter to continue.
7. On the Confirm Install Screen, press F11 to install.
8. On the Installation complete screen, press Enter to reboot.

Configuring ESXi after installation

1. On the ESXi 5.0 screen, press F2, enter the root password, and press Enter.
2. On the System Customization screen, select troubleshooting options, and press Enter.
3. On the Troubleshooting Mode Options screen, select enable ESXi Shell, and press Enter.
4. Select Enable SSH, press Enter, and press ESC.
5. On the System Customization screen, select Configure Management Network.
6. On the Configure Management Network screen, select IP Configuration.
7. On the IP Configuration screen, select Set static IP; enter an IP address, subnet mask, and default gateway; and press Enter.
8. On the Configure Management Network screen, press Esc. When asked if you want to apply the changes, press Y.
9. Log into view5 as root with the vSphere client.
10. Select the Configuration tab, and click Networking.
11. Click Add Networking...
12. Create a virtual machine network called data and select the appropriate adapter.
13. Create a vmkernel network called iSCSI and select the appropriate adapter.
14. Log off.

Installing VMware vSphere 4.1 (ESXi) on the PowerEdge R810 (view46)

1. Insert the ESXi 4.1 DVD, and restart the computer.
2. Boot the system from DVD.
3. On the VMware VMvisor Boot Menu, select ESXi Installer, and press Enter.
4. On the Welcome to VMware ESXi 4.1.0 Installation screen, click Enter.
5. On the EULA screen, press F11.
6. Select a disk on which to install ESXi, and press Enter.
7. To confirm install, press F11.
8. When the installation is complete, eject the DVD, and press Enter to reboot.
9. On the ESXi Screen, press F2 to Customize System.
10. On the Authentication Required Screen, log in as root with no password.
11. On the System Customization screen, select Configure Password.
12. On the Configure Password screen, enter your new password, confirm, and press Enter.
13. Select Configure Management Network, and press Enter.
14. Select IP Configuration, and press Enter.
15. On the IP Configuration screen, select Set static IP address and network configuration, and press the spacebar.
16. Enter the necessary network parameters, and press Enter.
17. Select DNS Configuration, and press Enter.

18. Select Use the following DNS server addresses and hostname.
19. Enter the IP address of the DNS server, and optionally, an alternate DNS server, and press Enter.
20. Press Esc when finished. On the Configure Management Network: Confirm pop-up, press Y to accept the changes, and restart the management network.
21. On the main System Customization screen, select Troubleshooting Options, and press Enter.
22. Select Enable Remote Tech Support (SSH), and press Enter.
23. Press Esc twice to log out.
24. Log into view46 as `root` with the vSphere client.
25. Select the Configuration tab, and click Networking.
26. Click Add Networking...
27. Create a virtual machine network called `data` and select the appropriate adapter.
28. Create a vmkernel network called `iSCSI` and select the appropriate adapter.
29. Log off.

Setting up a VM to host Microsoft Windows Active Directory server (DC1)

1. From a Microsoft Windows server or workstation, connect to the infra server via the VMware vSphere client.
2. Log in as `root` to the infra server.
3. In the vSphere client, connect to the vCenter Server, and browse to the ESXi host.
4. Click the Virtual Machines tab.
5. Right-click, and choose New Virtual Machine.
6. Choose Custom, and click Next.
7. Assign the name `DC1` to the virtual machine, and click Next.
8. Select `datastore1`, and click Next.
9. Choose Virtual Machine Version 8, and click Next.
10. Choose Windows, and choose Microsoft Windows Server 2008 R2 (64-bit), and click Next.
11. Choose two virtual processors, and click Next.
12. Choose 4GB RAM, and click Next.
13. Click 1 for the number of NICs, select E1000, connect to the data network, and click Next.
14. Leave the default virtual storage controller, and click Next.
15. Choose to create a new virtual disk, and click Next.
16. Make the OS virtual disk size 20 GB, choose thick-provisioned lazy zeroed, specify the OS datastore on the external storage, and click Next.
17. Keep the default virtual device node (0:0), and click Next.
18. Click Finish.
19. Right-click the VM, and choose Edit Settings.
20. On the Hardware tab, click Add...
21. Click Hard Disk, and click Next.
22. Click Create a new virtual disk, and click Next.
23. Specify 10GB for the virtual disk size, choose thick-provisioned lazy zeroed, and specify `datastore1`.
24. Choose `SCSI(1:2)` for the device node, and click Next.
25. On the Hardware tab, click Add...
26. Click Finish, and click OK.
27. Click the Resources tab, and click Memory.
28. Connect the VM virtual CD-ROM to the Microsoft Windows Server 2008 R2 installation disk.
29. Start the VM.

Installing the Microsoft Windows Server 2008 R2 operating system on the VM

1. Choose the language, time and currency, and keyboard input. Click Next.
2. Click Install Now.

3. Choose Windows Server 2008 R2 Enterprise (Full Installation), and click Next.
4. Accept the license terms, and click Next.
5. Click Custom.
6. Click the Disk, and click Drive options (advanced).
7. Click New→Apply→Format, and click Next.
8. After the installation completes, click OK to set the Administrator password.
9. Enter the administrator password twice, and click OK.
10. Connect the machine to the Internet, and install all available Windows updates. Restart as necessary.
11. Enable remote desktop access.
12. Change the hostname to DC1 and reboot when prompted.
13. Run diskmgmt.msc.
14. Select the 10 GB secondary volume, format it NTFS, and assign it drive letter E
15. Set up networking for the data network:
 - a. Click Start→Control Panel, right-click Network Connections, and choose Open.
 - b. Right-click the VM traffic NIC, and choose Properties.
 - c. Uncheck TCP/IP (v6).
 - d. Select TCP/IP (v4), and choose Properties.
 - e. Set the IP address, subnet, gateway, and DNS server.

Installing Active Directory and DNS services on DC1

1. Click Start→Run, type `dcpromo` and click OK.
2. At the Active Directory Domain Services Installation Wizard welcome screen, check the Use advanced mode installation option, and click Next.
3. In the Choose a Deployment Configuration dialog box, select Create a new domain in a new forest, and click Next.
4. At the FQDN page, type `VDI.com` and click Next.
5. At the NetBIOS name prompt, leave the name VDI, and click Next.
6. At the Forest Functionality level, select Windows Server 2008 R2, and click Next.
7. At the additional Domain Controller Options, leave DNS server selected, and click Next.
8. At the System Folder Location screen, change to `E:\` leave the default options, and click Next.
9. Assign a Directory Services Restore Mode Administrator account password, and click Next.
10. At the Summary screen, review your selections, and click Next.
11. Once Active Directory Domain Services finishes installing, click Finish, and restart the system.
12. Run `dnsmgmt.msc`.
13. Create a reverse lookup zone for DC1.
14. Create static entries for `infra`, `view5`, and `view46`.

Configuring the Windows time service on DC1

To ensure reliable time, we pointed our Active Directory server to a physical NTP server.

1. Open a command prompt.
2. Type the following:

```
32tm /config /syncfromflags:manual /manualpeerlist:"<ip address of a NTP server>"
W32tm /config /reliable:yes
W32tm /config /update
W32tm /resync
Net stop w32time
Net start w32time
```

Configuring the PCOIP GPO to turn off

1. In the Active Directory users and computers MMC plugin, create an OU in Active Directory called `No-build-to-lossless`
2. Open the Group policy editor.
3. Create a new GPO called `No-Build to lossless`
4. Click Administrative templates, and click Add/remove templates...
5. Browse to the `pcoip.adm` on the View 5 install DVD, and click Open.
6. In the GPO, browse to Computer Configuration→Administrative Template→Classic Administrative Template (ADM)→PCoIP Session Variables→ Not Overridable Administrative settings, and click Turn off Build-to-lossless feature. Right click, and click Edit.
7. Select the radio button for Enabled, and tick the box next to I accept to turn off the Build-to-lossless feature.
8. Click OK.

Setting up the Login VSI share and Active Directory users

For Login VSI to work correctly a CIFS share, Active directory OU, and Active directory users must be created. For more information on Login VSI, see <http://www.loginvsi.com/en/admin-guide/installation.html>

1. Open Windows Explorer and create a file called `share`
2. Assign permissions of read/write to the VDI/everyone group.
3. From the login VSI 3oRelease 6 media, run the login VSI AD Setup.
4. Keep the defaults, and click Start.

Setting up VMs to host the vCenter servers (vCenter 5, and vCenter4)

1. From a Microsoft Windows server or workstation, connect to the infra server via the vSphere client.
2. Log into infra with the VMware vSphere client.
3. In the vSphere client, connect to the vCenter Server, and browse to the ESXi host.
4. Click the Virtual Machines tab.
5. Right-click, and choose New Virtual Machine.
6. Choose Custom, and click Next.
7. Assign the name `vCenter5` to the virtual machine, and click Next.
8. Select the Datastore on the storage, and click Next.
9. Choose Virtual Machine Version 8, and click Next.
10. Choose Windows, choose Microsoft Windows Server 2008 R2 (64-bit), and click Next.
11. Choose two virtual processors, and click Next.
12. Choose 4GB RAM, and click Next.
13. Click 1 for the number of NICs, select E1000, connect to the data network, and click Next.
14. Leave the default virtual storage controller, and click Next.
15. Choose to create a new virtual disk, and click Next.
16. Make the OS virtual disk size 40 GB, choose thick-provisioned lazy zeroed, specify the OS datastore on the external storage, and click Next.
17. Keep the default virtual device node (0:0), and click Next.
18. Connect the VM virtual CDROM to the Microsoft Windows 2008 R2 installation disk.
19. Click Finish.
20. Start the VM.

Installing the Microsoft Windows Server 2008 R2 operating system on the VM

1. Choose the language, time and currency, and keyboard input. Click Next.
2. Click Install Now.
3. Choose Windows Server 2008 R2 Enterprise (Full Installation), and click Next.

4. Accept the license terms, and click Next.
5. Click Custom.
6. Click the Disk, and click Drive options (advanced).
7. Click New→Apply→Format, and click Next.
8. After the installation completes, click OK to set the Administrator password.
9. Enter the administrator password twice, and click OK.
10. Connect the machine to the Internet, and install all available Windows updates. Restart as necessary.
11. Enable remote desktop access.
12. Change the hostname to `vCenter5` and reboot when prompted.
13. Set up networking for the data network:
 - a. Click Start, Control Panel, right-click Network Connections, and choose Open.
 - b. Right-click the VM traffic NIC, and choose Properties.
 - c. Uncheck TCP/IP (v6).
 - d. Select TCP/IP (v4), and choose Properties.
 - e. Set the IP address, subnet, gateway, and DNS server.
14. Join the VDI domain.
15. Reboot the system.
16. Repeat steps 1 through 20 in the Setting up VMs to host the vCenter servers (vCenter 5, and vCenter4) section, and steps 1 through 15 above to create a VM called `vCenter4`

Installing vCenter 5

1. Log onto the vCenter 5 as `VDI\administrator`
2. From the VMware vCenter5 install media, click Autorun.
3. Click Run to start the install wizard.
4. Click the install button on the VMware vSphere 5.0 wizard.
5. Select the install wizard language as English, and click OK.
6. At the install wizard welcome screen, click Next.
7. Agree to the license agreement, and click Next.
8. Enter user information and a license key, and click Next.
9. Select Install the SQL express instance, and click Next.
10. Select the system account for the vCenter Server service account, and click Next.
11. Keep the installation directory as `C:\Program Files\VMware\Infrastructure\`, and click Next.
12. Select Create a standalone VMware vCenter Server instance, and click Next.
13. Keep the vCenter default ports, and click Next.
14. Select 1024 MB for the JVM memory, and click Next.
15. Click Install to finish the vCenter server installation.
16. Restart the server when complete.
17. Using the vSphere client, log into vCenter5 as `VDI\administrator`
18. Right-click the root of vCenter5, and click New Data center.
19. Name the New datacenter `View5-DC`
20. Add the ESX server named `view5` to the datacenter.
21. Log out.

Configuring iSCSI networking on ESXi (view5)

We followed the steps from VMware's document, iSCSI SAN Configuration Guide version 4.1, as a guide for our configuration of iSCSI on VMware vSphere 5.0. However, we performed most steps in the VMware vSphere 5.0 client UI as opposed to the command line, as VMware has added the relevant features to the UI in vSphere 5.0.

1. Using the vSphere client from another machine, connect to the ESXi server.

2. Add the necessary vSwitches:
 - a. Click the host, click the Configuration tab, and click Networking.
 - b. Click Add Networking.
 - c. Choose VMkernel, and click Next.
 - d. Choose create a vSphere standard switch.
 - e. Choose the first onboard NIC associated with iSCSI traffic.
 - f. Assign the network label, and assign IP settings.
 - g. Click Finish.
 - h. Repeat steps b through g for the remaining NIC assigned to iSCSI traffic.
3. Add the iSCSI software storage adapter:
 - a. Click the host, click the Configuration tab, and click Storage adapters.
 - b. Click Add.
 - c. Click Add software iSCSI adapter.
 - d. Click OK.
4. Configure the iSCSI software storage adapter:
 - a. Right-click the iSCSI adapter that was just added to the system, choose Properties, and ensure it is enabled.
 - b. Inside the iSCSI adapter Properties window, click the Network Configuration tab.
 - c. Under VMkernel port bindings, click Add, and add each VMkernel adapter to the VMkernel port bindings list.
5. Enable jumbo frames in ESXi:
 - a. Click the host, click the Configuration tab, and click Networking.
 - b. On the first vSwitch used for iSCSI, click Properties.
 - c. Select the vSwitch.
 - d. Click Edit.
 - e. Modify the MTU to 9,000.
 - f. Click OK.
 - g. In the vSwitch Properties window, choose the VMkernel port.
 - h. Click Edit.
 - i. Modify the MTU to 9,000.
 - j. Click OK.
 - k. Click Yes if warned about datastore access.
 - l. Click Close.
6. Access provisioned Dell EqualLogic storage:
 - a. Using the Dell EqualLogic Web UI, ensure the VMware View 5-specific volume is online and the VMware View 4.6-specific volume is offline.
 - b. In the vSphere client, click the host, click the Configuration tab, and click Storage adapters.
 - c. Right-click the iSCSI software storage adapter.
 - d. Click Dynamic discovery.
 - e. Click Add.
 - f. Enter the Dell EqualLogic group IP address.
 - g. Click Close.
 - h. Click Yes when prompted to rescan the HBA.

Installing the Dell EqualLogic Multipathing Extension Module (MEM) version 1.1 Beta on the ESXi server

1. Using a file transfer utility, copy the MEM installation ZIP file to the ESXi server.
2. Use the following command to install the Dell EqualLogic MEM beta. Consult the installation and user guide for more details on the VMware MEM integration.

```
esxcli software vib install -d membundlename.zip --no-sig-check
```

- Using the Dell EqualLogic Multipathing Extension Module Installation and User Guide, verify that the MEM is functional in vSphere.

Installing vCenter 4.1

- Log into the VM named vCenter4 as VDI\administrator
- From the VMware vCenter4 install media, click Autorun.
- Click vCenter Server.
- Select the install wizard language as English, and click OK.
- At the install wizard welcome screen, click Next.
- Agree to the license agreement, and click Next.
- Enter user information and a license key, and click Next.
- Select Install the SQL express instance, and click Next.
- Select the system account for the vCenter Server service account, and click Next.
- Keep the installation directory as C:\Program Files\VMware\Infrastructure\, and click Next.
- Select Create a standalone VMware vCenter Server instance, and click Next.
- Keep the vCenter default ports, and click Next.
- Click install to finish the vCenter server installation.
- Restart the server when complete.
- Using the vSphere client, log into vCenter5 as VDI\administrator
- Right-click the root of vCenter4, and click New Data center.
- Name the New datacenter View4-DC
- Add the ESX server named view46 to the datacenter.

Installing the vSphere client and vSphere CLI

Required materials:

- One auxiliary system (guest, netbook, or server) with a recent Windows OS and with network connection to the VMware management network.
 - vSphere client 4.1 installer, available from <http://vsphereclient.vmware.com/vsphereclient/3/4/5/0/4/3/VMware-viclient-all-4.1.0-345043.exe>.
 - vSphere CLI 4.1 installer is available for Windows or 32-/64-bit Linux from <http://downloads.vmware.com/d/details/vcli41/ZHcqYmRoaCpiZHRAag==>
- On the auxiliary system, run the vSphere installer VMware-viclient-all-4.1.0-345043.exe.
 - On the same host, run the vSphere CLI installer.

Configuring the iSCSI network for the Dell EqualLogic Multipath Extension Module

- Create a new vSwitch for each NIC dedicated to iSCSI traffic.
- In each vSwitch, create a new VMkernel, using each dedicated iSCSI NIC and assigning a valid IP address for the storage network.
- Under Storage adapters, create a new software iSCSI adapter, and bind all the iSCSI VMkernels to the adapter.

Installing the Dell ESX Multipath Extension Module

- To install the EqualLogic ESX Multipath Extension Module, download the package from Dell (support contract required) at https://www.equallogic.com/support/download_file.aspx?id=946.
- Unzip the package, and change the directory to EqualLogic-ESX-Multipathing-Module.
- Determine whether the module is already installed with this command:
> setup.pl --query --server=view46.VDI.com --username=root \
--password=Password1
- If needed, install it with this command:
> setup.pl --install --server=view46.VDI.com --username=root \

```
--password=Password1
```

5. Reboot the ESXi server.

6. Verify that the module is active:

```
> setup.pl --query --server=view46.VDI.com --username=root \  
--password=Password1
```

Setting up a Windows 7 Enterprise x64 image for two VMware View virtual desktops and two Login VSI launchers

Using the vSphere client, we created four identical Windows 7 Enterprise x64 VMs using a base image (see below): two of them on the server named infra, one on the view5 server, and one on the view46 server.

We configured the Windows 7 Enterprise x64 VMs on the infra server to be Login VSI launchers, one for VMware View 5.0 testing, and another for View 4.6 testing. We configured the Windows 7 Enterprise x64 VM on the view5 server to be the virtual desktop template for VMware View 5.0 testing. We configured the Windows 7 Enterprise x64 VM on the view46 server to be the virtual desktop template for View 4.6.

For the Login VSI launcher VMs, after the base image, we installed the View 5 and View 4.6 clients on the respective VMs, added them to the Login VSI OU in Active Directory, and then installed the Login VSI Launcher setup on both.

For the virtual desktop images, we optimized the Microsoft Windows 7 OS for both, installed Microsoft Office 2007, installed the Login VSI target software, added them to the Login VSI OU, and installed the respective VMware View 5 and 4.6 agents. We then copied five View 4.6 virtual desktops, and copied five more virtual desktops. We customized the virtual desktops using Microsoft Sysprep.

Installing the Windows 7 Enterprise (x64) base image

For all Login VSI launchers and for virtual desktops, we used the same base Windows 7 installation procedure.

1. Log into the appropriate vCenter.
2. In the vSphere client, connect to the vCenter Server, and browse to the ESXi host.
3. Click the Virtual Machines tab.
4. Right-click, and choose New Virtual Machine.
5. Choose Custom, and click Next.
6. Assign the name DC1 to the virtual machine, and click Next.
7. Select datastore1, and click Next.
8. Choose Virtual Machine Version 8, and click Next.
9. Choose Windows, choose Microsoft Windows 7 (64-bit), and click Next.
10. Choose two virtual processors, and click Next.
11. Choose 2GB RAM, and click Next.
12. Click 1 for the number of NICs, select E1000, and click Next.
13. Leave the default virtual storage controller, and click Next.
14. Choose to create a new virtual disk, and click Next.
15. Make the OS virtual disk size 20 GB, choose thick-provisioned lazy zeroed, specify the OS datastore on the external storage, and click Next.
16. Keep the default virtual device node (0:0), and click Next.
17. Click Finish.
18. Click Finish, and click OK.
19. Click the Resources tab, and click Memory.
20. Connect the VM virtual CD-ROM to the Microsoft Windows 7 x64 installation disk.

21. Start the VM.
19. When the installation prompts you, press any key to begin setup.
20. Enter your language preferences, and click Next.
21. Click Install.
22. Accept the license terms, and click Next.
23. Select Custom, and select the drive that will contain the OS.
24. Click Install, and the setup begins.
25. Type `user` for the username and change the computer name, and click Next.
26. Enter no password, and click Next.
27. For system protection, select Use recommended settings, and click Next.
28. Enter your time zone, and click Next.
29. Select the Work Network setting, and click Next.
30. Use Windows Update to patch the Windows 7 installation.
31. Install VMware tools. For more information, see http://kb.vmware.com/selfservice/microsites/search.do?language=en_US&cmd=displayKC&externalId=340
32. Reboot.
33. Repeat steps 1 through 35 to create a total of four VMs: two in the infra server, and one each on the view46 and view5 servers.

Installing Windows 7 Enterprise, (x64) optimizing Windows 7

Adjusting page file

1. Log in as `administrator`
2. Right-click Computer → Properties → Change settings → Advanced → Performance → Settings.
3. In Performance settings, select the Advanced tab, and select Change for Virtual Memory.
4. Deselect automatically manage page file.
5. Select Custom size, type `2048` for both values, and select Set.

Disabling Windows Firewall

The domain GPO automatically disables the Windows Firewall.

Installing Office 2007 Professional

1. From the Office 2007 media, run Setup.
2. Enter the product key for Office 2007, and click Continue.
3. Accept the licensing agreement.
4. Select Custom install.
5. At the root of the installation options, ensure that all Office components are set to Run from My Computer.
6. Click Install.
7. Download and run Office 2007 Service Pack 2.
8. Reboot the system.

Installing Login VSI target software on Windows 7 virtual desktop

1. Browse to `\vsi-install\Target setup`.
2. Run the `setup.exe`.
3. In the Target Setup wizard, specify the VSI share (\\dc1\share).
4. Click Start.
5. When prompted with security warnings, click OK.
6. Reboot the system.

Cleaning up the VM on Windows 7 virtual desktop

1. Click Start → Run → `services.msc`.

2. In the Services menu, select Windows Search, and change it from Disabled to Automatic (delayed start).
3. Close the Services menu.
4. Click Start→Control Panel →View Devices and Printers.
5. In the Services and Printers window, delete the following:
 - XPS printers and document writers

Optimizing bandwidth conservation on Windows 7 virtual desktop

1. For each desktop image, we disabled the following services:
 - Background Intelligent Transfer Service
 - Desktop Windows Manager Session Manager
 - Function Discovery Resource Publication
 - Home Group Listener
 - Home Group Provider
 - Indexing Service
 - Offline Files
 - Security Center
 - SuperFetch
 - System Restore
 - Themes
 - Windows Defender
 - Windows Media Player Network Sharing Service
 - Windows Search
2. Disable the boot animation with the following command:

```
bcdedit /set bootux disabled
```
3. Open the System Properties, click the Advanced tab, and select Performance.
4. Under Visual Effects, select Custom, and remove the following:
 - a. Animate windows when minimizing
 - b. Animations in the taskbar and start menu
 - c. Show translucent selection rectangle
 - d. Show windowed content while dragging
 - e. Smooth edges and screen fonts
 - f. Use drop shadows for icon labels on the desktop

Preparing for VMware View deployment on the Windows 7 VM

Install the VMware View agent on both the View 5 and View 4.6 virtual desktop images, and power each off. Clone the View 5 image five times to have five virtual desktops on the ESX server named view5 and name the VMs View5VDT1 through View5VDT5. In the same manner, copy the View 4.6 image to create five View 4.6 virtual desktops on the view46 server. Name the View 4.6 VMs View46VDT1 through View46VDT5.

Setting up VMs to host the VMware View connection servers (view5 and view46)

1. Log into infra with the VMware vSphere client.
2. In the vSphere client, connect to the vCenter Server, and browse to the ESXi host.
3. Click the Virtual Machines tab.
4. Right-click, and choose New Virtual Machine.
5. Choose Custom, and click Next.
6. Assign the name View5 to the virtual machine, and click Next.
7. Select the Datastore on the storage, and click Next.

8. Choose Virtual Machine Version 8, and click Next.
9. Choose Windows, choose Microsoft Windows Server 2008 R2 (64-bit), and click Next.
10. Choose two virtual processors, and click Next.
11. Choose 4GB RAM, and click Next.
12. Click 1 for the number of NICs, select E1000, connect to the data network, and click Next.
13. Leave the default virtual storage controller, and click Next.
14. Choose to create a new virtual disk, and click Next.
15. Make the OS virtual disk size 40 GB, choose thick-provisioned lazy zeroed, specify the OS datastore on the external storage, and click Next.
16. Keep the default virtual device node (0:0), and click Next.
17. Connect the VM virtual CD-ROM to the Microsoft Windows Server 2008 R2 installation disk.
18. Click Finish.
19. Start the VM.

Installing the Microsoft Windows Server 2008 R2 operating system on the VM

1. Choose the language, time and currency, and keyboard input. Click Next.
2. Click Install Now.
3. Choose Windows Server 2008 R2 Enterprise (Full Installation), and click Next.
4. Accept the license terms, and click Next.
5. Click Custom.
6. Click the Disk, and click Drive options (advanced).
7. Click New→Apply→Format, and click Next.
8. After the installation completes, click OK to set the Administrator password.
9. Enter the administrator password twice, and click OK.
10. Connect the machine to the Internet, and install all available Windows updates. Restart as necessary.
11. Enable remote desktop access.
12. Change the hostname to `view5` and reboot when prompted.
13. Set up networking for the data network:
 - a. Click Start→Control Panel, right-click Network Connections, and choose Open.
 - b. Right-click the VM traffic NIC, and choose Properties.
 - c. Uncheck TCP/IP (v6).
 - d. Select TCP/IP (v4), and choose Properties.
 - e. Set the IP address, subnet, gateway, and DNS server.
14. Join the VDI domain.
15. Reboot.
16. Repeat steps 1 through 19 in the Setting up VMs to host the VMware View connection servers (view5 and view 46) section, and steps 1 through 15 above to create a VM called `View46`

Installing the VMware View 5 server

1. Log into the server named `view5`.
2. Click Install Media for View Connection Server by running the `VMware-viewconnectionserver-x86_x64-443491.exe` file.
3. To begin the install wizard, click Next.
4. Agree to the license agreement, and click Next.
5. Keep the destination directory as `C:\Program Files\VMware View\Server\`, and click Next.
6. Select View Standard Server, and click Next.
7. Allow View Server to configure the firewall, and click Next.
8. Click Next.
9. Click Finish.

10. Log onto the DC, and add the server account for view5 to the disable build-to-lossless OU.
11. Open a command window, and type `gpupdate /force`
12. Reboot the View 5 server.
13. Log out of DC1.

Configuring the View 5 server - creating a pool and adding entitlements for Login VSI users

1. Open the View Administrator.
2. Log in as VDI administrator
3. Click Pools, and in the right windows, click Add...
4. Select Manual Pool, and click Next.
5. Select Dedicated, disable Automatic assignment, and click Next.
6. Select the Desktop sources as vCenter virtual machines, and click Next.
7. Use the vcenter4(administrator) as the source, and click Next.
8. Type `pool` for the pool ID and display name, and click Next.
9. Leave the pool settings as defaults, and click Next.
10. Select the five virtual desktops in the add vCenter Virtual Machines box, and click Next.
11. Click Finish to create the pool.
12. Click the desktop icon, and in the right window, click the first desktop.
13. Click More Commands→Assign User...
14. Add the user `login_VSI1`, and click OK.
15. Add users `login_VSI2` through 5 to the individual desktops in sequence.
16. Ensure all five desktops have a status of ready.

Installing the VMware View 4.6 server

1. Log into the server named view46.
2. Click Install Media for View Connection Server by running the `VMware-viewconnectionserver-x86_64-4.6.0-366101.exe`.
3. To begin the install wizard, click Next.
4. Agree to the license agreement, and click Next.
5. Keep the destination directory as `C:\Program Files\VMware View\Server\`, and click Next.
6. Select View Standard Server, and click Next.
7. Allow View Server to configure the firewall, and click Next.
8. Click Next.
9. Click Finish.

Configuring the View 5 server - creating a pool

1. Open the View Administrator.
2. Log in as VDI administrator
3. Click Pools, and in the right window, click Add...
4. Select Manual Pool, and click Next.
5. Select Dedicated, disable Automatic assignment, and click Next.
6. Select the Desktop sources as vCenter virtual machines, and click Next.
7. Use the vcenter5(administrator) as the source, and click Next.
8. Type `pool` for the pool ID and display name, and click Next.
9. Leave the pool settings as defaults, and click Next.

10. Select the five virtual desktops in the add vCenter Virtual Machines box, and click Next.
11. Click Finish to create the pool.
12. Click the desktop icon, and in the right window, click the first desktop.
13. Click More Commands→Assign User...
14. Add the user login_VSI1, and click OK.
15. Add users login_VSI2 through 5 to the individual desktops in sequence.
16. Ensure all five desktops have a status of ready.

APPENDIX C: LOGIN VSI INI FILES USED FOR TESTING

VMware View 5 launcher.ini

```
[Launcher]
Servername=
Username=
Password=
Domain=
ConnectionType="Custom with CSV file"
ConnectionNumber=User
CCL=c:\program files\VMware\VMWare View\Client\bin\wswc.exe -serverURL http://VIEW5 -username %CSV_User% -
password Password1 -domainname VDI -desktopname pool -Standalone -logInAsCurrentUser False -
connectUSBOnStartup False
CSV=\\DC1\Share\csv\view5-user.csv
Launchmode=Sequential
ParallelDelay=30
ParallelTimeframe=120
InitialStartNumber=1
NumberOfSessions=5
SequentialInterval=30
Fancy_number=1
Autologoff=1
LogoffTimeOut=120
CreateProfile=0
UseLocalLauncher=0
```

VMware View 4.6 launcher.ini

```
[Launcher]
Servername=
Username=
Password=
Domain=
ConnectionType="Custom with CSV file"
ConnectionNumber=User
CCL=c:\program files\VMware\VMWare View\Client\bin\wswc.exe -serverURL http://view46 -username %CSV_User% -
password Password1 -domainname VDI -desktopname pool -Standalone -logInAsCurrentUser False -
connectUSBOnStartup False
CSV=\\DC1\Share\csv\view5-user.csv
Launchmode=Sequential
ParallelDelay=30
ParallelTimeframe=120
InitialStartNumber=1
NumberOfSessions=5
SequentialInterval=30
Fancy_number=1
Autologoff=1
LogoffTimeOut=120
```

CreateProfile=0
UseLocalLauncher=0

User.csv

User
login_vsi1
login_vsi2
login_vsi3
login_vsi4
login_vsi5

ABOUT PRINCIPLED TECHNOLOGIES



Principled Technologies, Inc.
1007 Slater Road, Suite 300
Durham, NC, 27703
www.principledtechnologies.com

We provide industry-leading technology assessment and fact-based marketing services. We bring to every assignment extensive experience with and expertise in all aspects of technology testing and analysis, from researching new technologies, to developing new methodologies, to testing with existing and new tools.

When the assessment is complete, we know how to present the results to a broad range of target audiences. We provide our clients with the materials they need, from market-focused data to use in their own collateral to custom sales aids, such as test reports, performance assessments, and white papers. Every document reflects the results of our trusted independent analysis.

We provide customized services that focus on our clients' individual requirements. Whether the technology involves hardware, software, Web sites, or services, we offer the experience, expertise, and tools to help our clients assess how it will fare against its competition, its performance, its market readiness, and its quality and reliability.

Our founders, Mark L. Van Name and Bill Catchings, have worked together in technology assessment for over 20 years. As journalists, they published over a thousand articles on a wide array of technology subjects. They created and led the Ziff-Davis Benchmark Operation, which developed such industry-standard benchmarks as Ziff Davis Media's Winstone and WebBench. They founded and led eTesting Labs, and after the acquisition of that company by Lionbridge Technologies were the head and CTO of VeriTest.

Principled Technologies is a registered trademark of Principled Technologies, Inc.
All other product names are the trademarks of their respective owners.

Disclaimer of Warranties; Limitation of Liability:

PRINCIPLED TECHNOLOGIES, INC. HAS MADE REASONABLE EFFORTS TO ENSURE THE ACCURACY AND VALIDITY OF ITS TESTING, HOWEVER, PRINCIPLED TECHNOLOGIES, INC. SPECIFICALLY DISCLAIMS ANY WARRANTY, EXPRESSED OR IMPLIED, RELATING TO THE TEST RESULTS AND ANALYSIS, THEIR ACCURACY, COMPLETENESS OR QUALITY, INCLUDING ANY IMPLIED WARRANTY OF FITNESS FOR ANY PARTICULAR PURPOSE. ALL PERSONS OR ENTITIES RELYING ON THE RESULTS OF ANY TESTING DO SO AT THEIR OWN RISK, AND AGREE THAT PRINCIPLED TECHNOLOGIES, INC., ITS EMPLOYEES AND ITS SUBCONTRACTORS SHALL HAVE NO LIABILITY WHATSOEVER FROM ANY CLAIM OF LOSS OR DAMAGE ON ACCOUNT OF ANY ALLEGED ERROR OR DEFECT IN ANY TESTING PROCEDURE OR RESULT.

IN NO EVENT SHALL PRINCIPLED TECHNOLOGIES, INC. BE LIABLE FOR INDIRECT, SPECIAL, INCIDENTAL, OR CONSEQUENTIAL DAMAGES IN CONNECTION WITH ITS TESTING, EVEN IF ADVISED OF THE POSSIBILITY OF SUCH DAMAGES. IN NO EVENT SHALL PRINCIPLED TECHNOLOGIES, INC.'S LIABILITY, INCLUDING FOR DIRECT DAMAGES, EXCEED THE AMOUNTS PAID IN CONNECTION WITH PRINCIPLED TECHNOLOGIES, INC.'S TESTING. CUSTOMER'S SOLE AND EXCLUSIVE REMEDIES ARE AS SET FORTH HEREIN.
